

Your partner in spine surgery

NEURO FRANCE Implants
Spine

Distribuído por :

MORE
MEDICAL OPERATION RESOURCES FOR EXPERTS

NEURO FRANCE Implants - Fabricante e designer de implantes para cirurgias de coluna

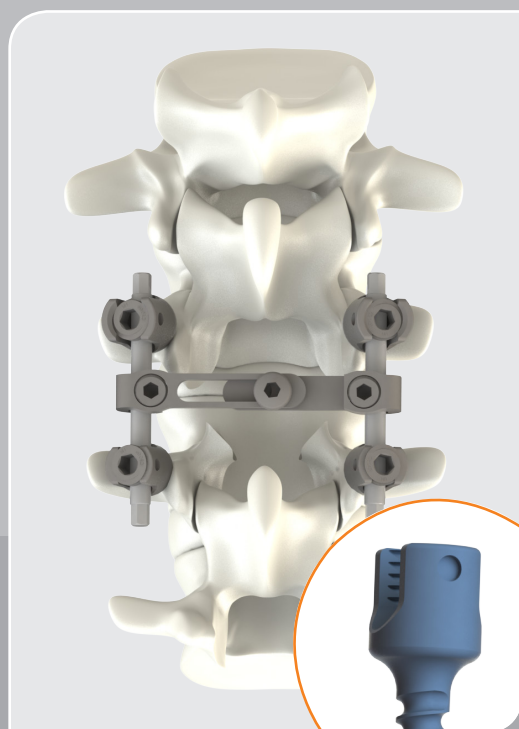

Km

SISTEMA DE FIXAÇÃO TORACOLOMBAR

CE
MARK

ISO
13485 : 2016

NEURO FRANCE Implants

ZA «le Bourg» - 25 rue des écoles 41160 La Ville aux Clercs - FRANCE

Phone : +33 2 54 80 90 90 - Fax : +33 2 54 80 83 33

Email : neurofrance@neuro-france.net

SISTEMA KM

PONTOS PRINCIPAIS :

- Abordagem posterior
- Sistema de barras (5 e 6 mm)
- Parafuso monoaxial e poliaxial
- Parafuso para espondilolistese
- Escoliose
- Compatibilidade com sistema KM BABY para fixação da transição cervico-torácica
- Compatibilidade com sistema SES para correção de deformidades

SISTEMA DE FIXAÇÃO TORACOLOMBAR

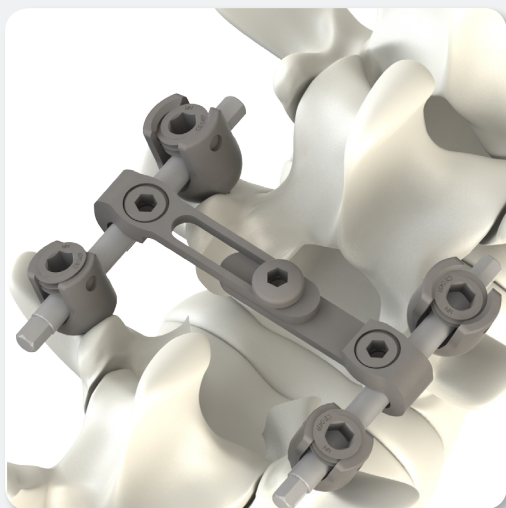

INDICAÇÕES

Coluna degenerativa
Traumas
Tumores
Escoliose/deformidades
Espondilolistese

COMPOSIÇÃO DO SISTEMA

Parafuso monoaxial e poliaxial
Parafuso monoaxial e poliaxial espôndilo
Gancho
Cross Link
Conectores
Set Instrumental



MATÉRIA PRIMA UTILIZADA

Todo sistema KM é fabricado em liga de titânio Ti 6-Al 4-V, em conformidade com a ISO 5832/3.

KM - IMPLANTES

PARAFUSO MONOAXIAL KM



Item n°	Ø Diam.	Comp. (L)	Cor ⁽¹⁾
204530	Ø 4,5 mm	L 30 mm	■
204535	Ø 4,5 mm	L 35 mm	■
205535	Ø 5,5 mm	L 35 mm	■
205540	Ø 5,5 mm	L 40 mm	■
205545	Ø 5,5 mm	L 45 mm	■
206535	Ø 6,5 mm	L 35 mm	■
206540	Ø 6,5 mm	L 40 mm	■
206545	Ø 6,5 mm	L 45 mm	■
206550	Ø 6,5 mm	L 50 mm	■
206555	Ø 6,5 mm	L 55 mm	■
207540	Ø 7,5 mm	L 40 mm	■
207545	Ø 7,5 mm	L 45 mm	■

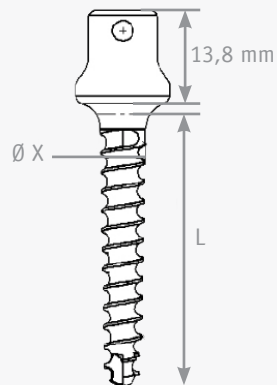

PARAFUSO POLIAXIAL KM



Item n°	Ø Diam.	Comp. (L)	Cor ⁽¹⁾
224525	Ø 4,5 mm	L 25 mm	■
224530	Ø 4,5 mm	L 30 mm	■
224535	Ø 4,5 mm	L 35 mm	■
224540	Ø 4,5 mm	L 40 mm	■
225530	Ø 5,5 mm	L 30 mm	■
225535	Ø 5,5 mm	L 35 mm	■
225540	Ø 5,5 mm	L 40 mm	■
225545	Ø 5,5 mm	L 45 mm	■
226535	Ø 6,5 mm	L 35 mm	■
226540	Ø 6,5 mm	L 40 mm	■
226545	Ø 6,5 mm	L 45 mm	■
226550	Ø 6,5 mm	L 50 mm	■
226555	Ø 6,5 mm	L 55 mm	■
227535	Ø 7,5 mm	L 35 mm	■
227540	Ø 7,5 mm	L 40 mm	■
227545	Ø 7,5 mm	L 45 mm	■
227550	Ø 7,5 mm	L 50 mm	■
227555	Ø 7,5 mm	L 55 mm	■
227560	Ø 7,5 mm	L 60 mm ⁽²⁾	■

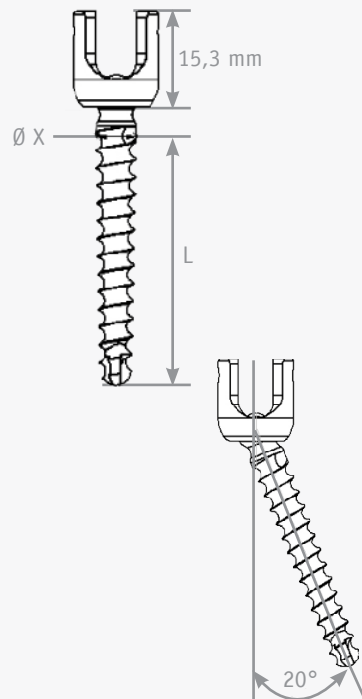

⁽¹⁾ Cores sob encomenda. ⁽²⁾ Item opcional
Parafusos auto-macheantes
Cada parafuso e gancho é fornecido com uma porca (550300)



Fotos meramente ilustrativas

KM- IMPLANTES

PARAFUSO MONOAXIAL ESPÔNDILO KM



Item n°	Ø Diam.	Comp. (L)	Cor*
216540	Ø 6,5 mm	L 40 mm	■
216545	Ø 6,5 mm	L 45 mm	■
217540	Ø 7,5 mm	L 40 mm	■
217545	Ø 7,5 mm	L 45 mm	■

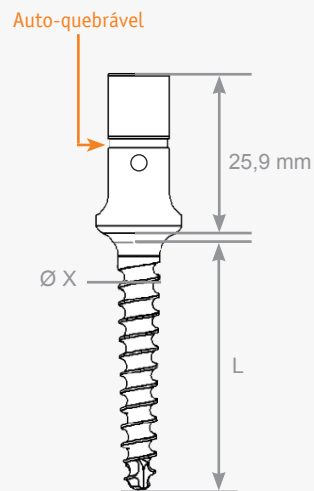

PARAFUSO POLIAXIAL ESPÔNDILO KM



Item n°	Ø Diam.	Comp. (L)	Cor*
235545	Ø 5,5 mm	L 45mm	■
236540	Ø 6,5 mm	L 40mm	■
236545	Ø 6,5 mm	L 45mm	■
236550	Ø 6,5 mm	L 50mm	■
236555	Ø 6,5 mm	L 55mm	■
237540	Ø 7,5 mm	L 40mm	■
237545	Ø 7,5 mm	L 45mm	■
237550	Ø 7,5 mm	L 50mm	■
237555	Ø 7,5 mm	L 55mm	■

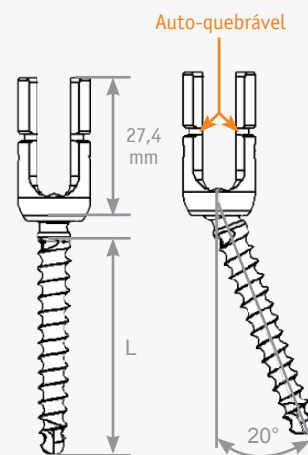

GANCHO KM



Item n°	Descrição	
200000	Gancho pedicular	1
200010	Gancho Laminar Lombar	2
200020	Gancho Laminar Torácico	3



* Cores sob encomenda.
Parafusos auto-macheantes
Cada parafuso e gancho é fornecido com uma porca (550300)



Fotos meramente ilustrativas

IMPLANTES CONECTORES

BARRAS COM EXTREMIDADE HEXAGONAL Ti 6-Al 4-V



Ø 5mm

Item n°	Comp. (L)
---------	-----------

405045	L 45,5 mm
405055	L 55,5 mm
405065	L 65 mm
405075	L 75 mm
405090	L 90 mm
405105	L 105 mm
405125	L 125 mm
405154	L 154 mm
405180	L 180 mm
405200	L 200 mm
405210	L 210 mm
405220	L 220 mm
405230	L 230 mm
405240	L 240 mm
405250	L 250 mm
405270	L 270 mm
405290	L 290 mm
405300	L 300 mm
405320	L 320 mm
405400	L 400 mm
405450	L 450 mm
405480	L 480 mm ⁽¹⁾



Ø 6mm

Item n°	Comp. (L)
---------	-----------

406045	L 45,5 mm
406055	L 55,5 mm
406065	L 65 mm
406075	L 75 mm
406090	L 90 mm
406105	L 105 mm
406125	L 125 mm
406154	L 154 mm
406180	L 180 mm
406200	L 200 mm
406210	L 210 mm ⁽¹⁾
406220	L 220 mm ⁽¹⁾
406230	L 230 mm
406240	L 240 mm ⁽¹⁾
406250	L 250 mm
406270	L 270 mm
406290	L 290 mm ⁽¹⁾
406300	L 300 mm
406320	L 320 mm ⁽¹⁾
406350	L 350 mm
406375	L 375 mm
406400	L 400 mm
406425	L 425 mm ⁽¹⁾
406450	L 450 mm ⁽¹⁾
406480	L 480 mm



⁽¹⁾ Item opcional.



IMPLANTES CONECTORES

CROSS LINK ARTICULADO



Item n°	Descrição
501029	De 29 a 35 mm
501034	De 34 a 45 mm
501044	De 44 a 65 mm
501064	De 64 a 105 mm

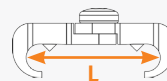

Cada cross link é fornecido com 3 porcas. ⁽¹⁾ Item opcional.



CONECTOR CILÍNDRICO



Item n°	Furos	Descrição
520256	4	Ø5/6mm (Inclui 4 porcas de fenda estrela) ⁽¹⁾
520266	4	Ø6/6mm (Inclui 4 porcas de fenda estrela)



Cada conector é fornecido com 4 porcas que possuem o mesmo número de lote do conector



IMPLANTES CONECTORES

CONECTOR QUADRADO



Item n°	Furos	Descrição
521035	4	Ø3/5mm (Inclui 4 porcas de fenda estrela)
521036	4	Ø3/6mm (Inclui 4 porcas de fenda estrela)
521056	4	Ø5/6mm (Inclui 4 porcas de fenda estrela)
521066	4	Ø6/6mm (Inclui 4 porcas de fenda estrela) <i>Item em fase de registro na Anvisa</i>



As porcas são fornecidas com o conector e possuem o mesmo número de lote do conector



KM- INSTRUMENTAIS

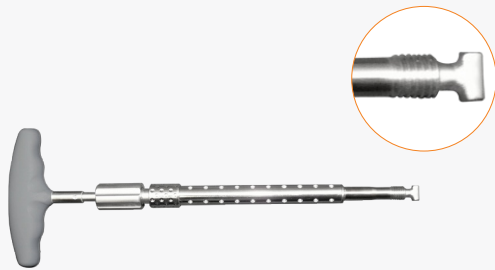

010100N Chave para Parafuso Monoaxial KM/CTJ

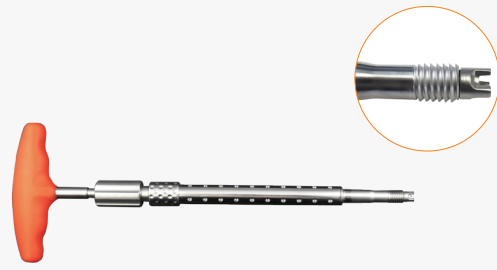

010200N Chave para Parafuso Poliaxial KM/CTJ

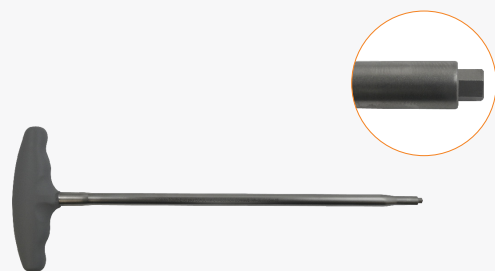

010505N Chave para Porca KM/CTJ - Não Cônico

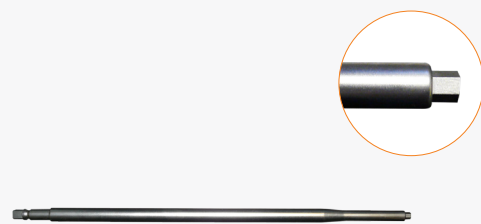

010505M Chave para porca KM - Não cônico



010503012 Torquimetro com Cabo em T

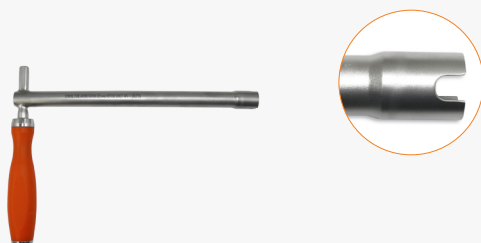

010610L Chave Anti-Rotação para Cabeça de Parafuso KM/CTJ

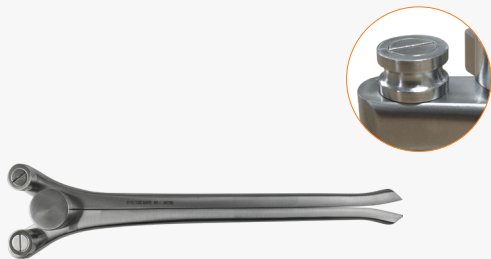

011100 Alicate Dobra Barra

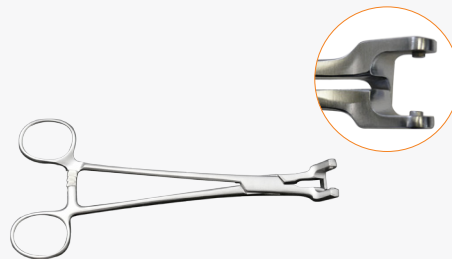

011300 Posicionador para Barra KM/CTJ

KM- INSTRUMENTAIS

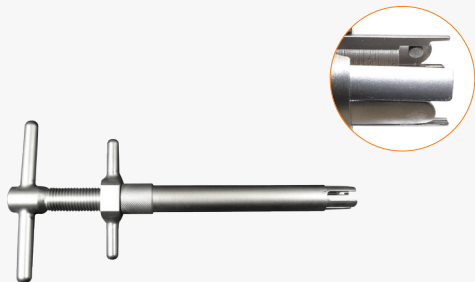

011301 Posicionador para Barra de Escoliose



011400 Derrotador de Barra



011410 Modelador para Barra - Direito

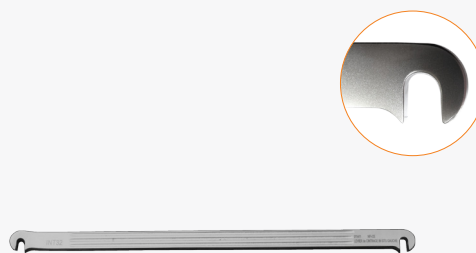

011411 Modelador para Barra - Esquerdo



013140 Macho de 4mm



015306 Pinça para Barra de 6mm

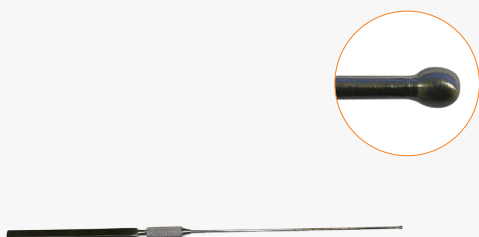

016103 Apalpador de Pedículo

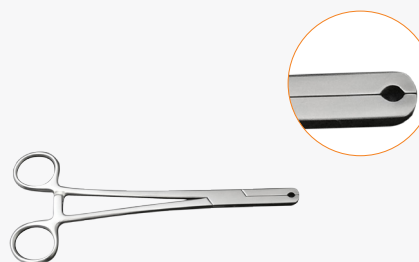

015207 Pinça para Barra de 5 e 6mm

KM - INSTRUMENTAIS

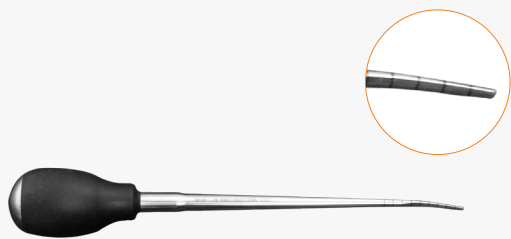

016203C Probe Curvada - Pequena

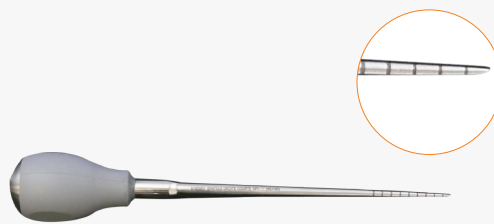

016202C Probe Reta - Pequena



010491 Segurador de Porca



010492 Segurador de Barra

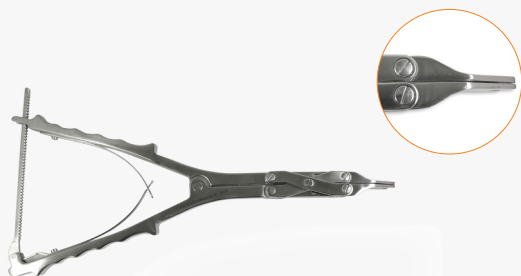

012102 Pinça de Distração Paralela KM/CTJ

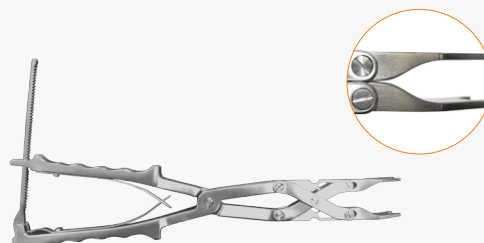

012202 Pinça de Compressão Paralela KM/CTJ



018000 Preparador para Gancho Tóraco Laminar KM

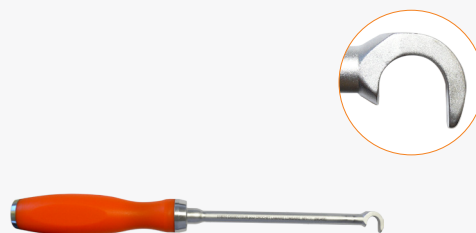

018010 Preparador para Gancho Lombar Laminar KM

KM - INSTRUMENTAIS



018020 Preparador para Gancho Pedicular

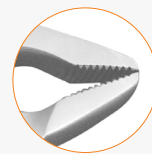

015406 Pinça de Aperto para Barra 6mm



010551 Chave 3,5mm para Cross Link Articulado

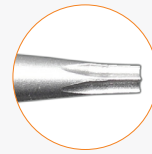

010540 Chave para Parafuso TORX - Fenda Estrela



014111 Iniciador KM Graduado



010602 Garfo Anti-Rotação para Cabeça de Parafuso KM/CTJ



015107 Abaixador de Barra



013150 Macho de 5mm

KM - INSTRUMENTAIS

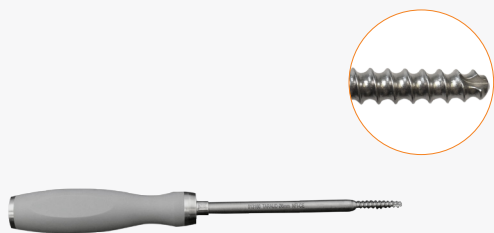

013160

Macho de 6mm

CONTAINER PARA TRANSPORTE

INSTRUMENTAIS KM
CONTAINER DE TRANSPORTE



Item n° : 0B0806

IMPLANTES KM
CONTAINER DE TRANSPORTE



Item n° : 0B0807

ANOTAÇÕES

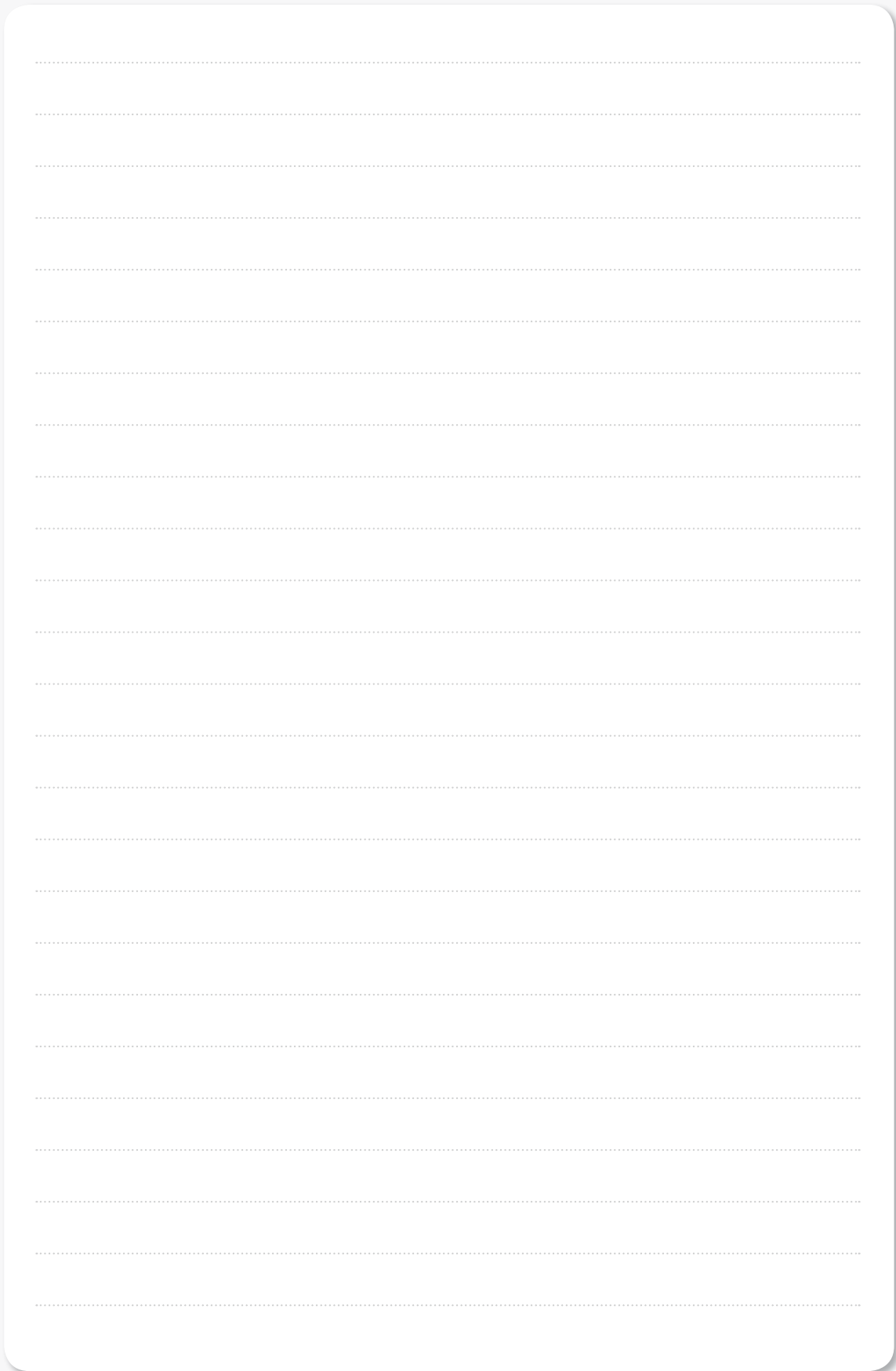

ANOTAÇÕES

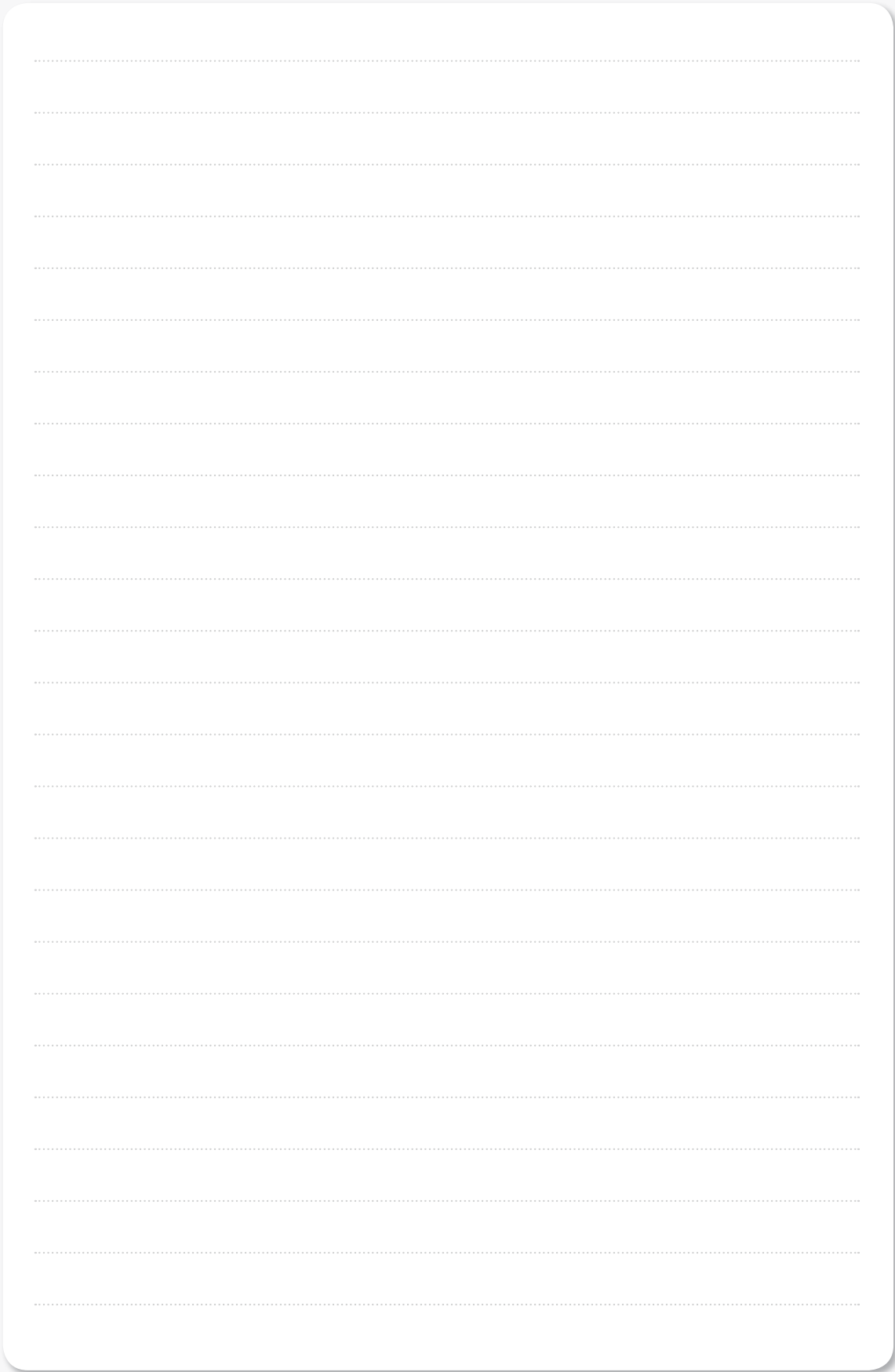

Your partner in spine surgery

NEURO FRANCE Implants



Spine

www.neuro-france.net

NEURO FRANCE Implants

ZA «le Bourg» - 25 rue des écoles 41160 La Ville aux Clercs - FRANCE

Phone : +33 2 54 80 90 90 - Fax : +33 2 54 80 83 33

Email : neurofrance@neuro-france.net



www.neuro-france.net

Distribuído por :



Avenida Luiz Eduardo Toledo Prado, 900 | sala: 619 - 620
Vila do Golf - Ribeirão Preto SP - Brasil CEP 14027-250