

Your partner in spine surgery

NEURO FRANCE Implants
Spine

MORE
MEDICAL OPERATION RESOURCES FOR EXPERTS

NEURO FRANCE Implants - Fabricante e designer de implantes para cirurgias de coluna

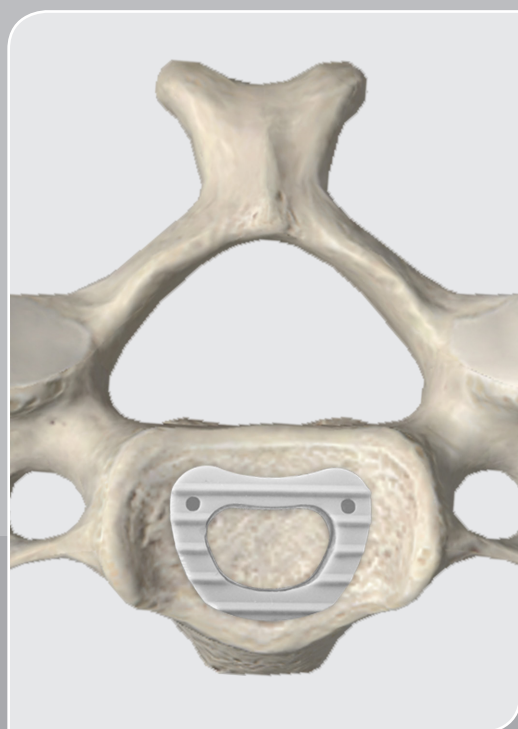

PM CAGE®

*SISTEMA DE FUSÃO
CERVICAL ANTERIOR*

CE
MARK

ISO
13485 : 2016

NEURO FRANCE Implants

ZA «le Bourg» - 25 rue des écoles 41160 La Ville aux Clercs - FRANCE

Phone : +33 2 54 80 90 90 - Fax : +33 2 54 80 83 33

Email : neurofrance@neuro-france.net

SISTEMA PM CAGE®

PONTOS PRINCIPAIS :

- Fusão intersomática cervical anterior
- PEEK OPTIMA® com marcadores radiopacos
- Design Anatômico
- Diversas opções de tamanho
- 4 graus de lordose
- Grande superfície de enxerto
- Cage Stand-alone - 1 nível

FUSÃO CERVICAL

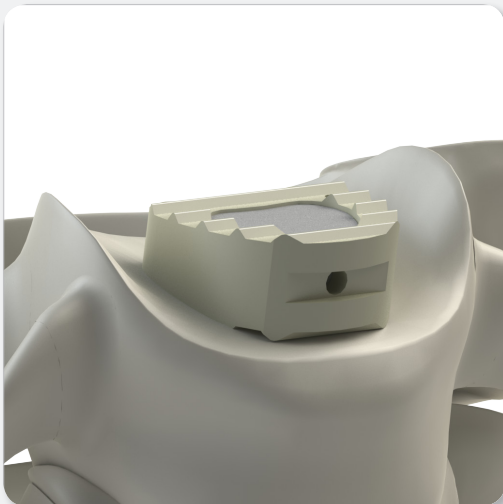
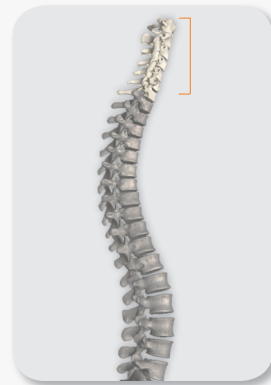

INDICAÇÕES

- Coluna degenerativa
- Hérnia de disco recorrente
- Traumas
- Instabilidade Cervical
- Neuralgia cervicobraquial
- Uncoartrose

COMPOSIÇÃO DO SISTEMA

PM CAGE® Pequeno

PM CAGE® Grande

Set instrumental

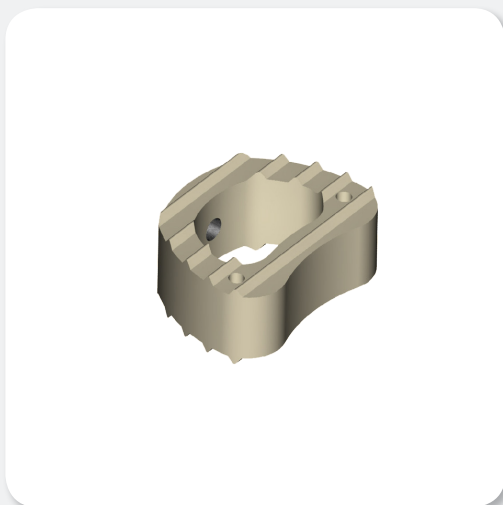

MATÉRIA PRIMA UTILIZADA

Os cages são feitos de PEEK OPTIMA com marcadores de raio x em liga de titânio Ti 6-Al 4-V, em conformidade com o padrão ISO 5832/3.

PM CAGE® - IMPLANTES

PM CAGE® PEQUENO



PEEK OPTIMA

Item n°	Larg.	Tam.
611304	13,7mm	H 4 mm S4
611305	13,7mm	H 5 mm S5
611306	13,7mm	H 6 mm S6
611307	13,7mm	H 7 mm S7
611308	13,7mm	H 8 mm S8
611309	13,7mm	H 9 mm S9
611310	13,7mm	H 10 mm S10
611311	13,7mm	H 11 mm S11

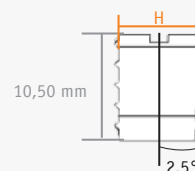

PM CAGE® GRANDE



PEEK OPTIMA

Item n°	Larg.	Tam.
611504	15,7mm	H 4 mm L4
611505	15,7mm	H 5 mm L5
611506	15,7mm	H 6 mm L6
611507	15,7mm	H 7 mm L7
611508	15,7mm	H 8 mm L8
611509	15,7mm	H 9 mm L9
611510	15,7mm	H 10 mm L10
611511	15,7mm	H 11 mm L11

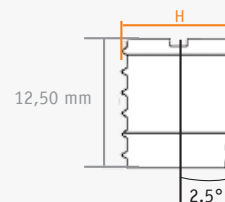

PM CAGE® - INSTRUMENTAIS



010910 Inserto para Cage Metálico PM

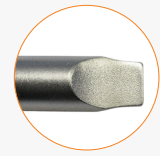

010915 Impactor PM CAGE®

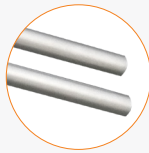

012300 Pinça Caspar Distratora (Direito)

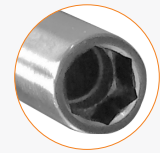

012305 Chave Caspar

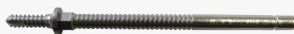

012312 Pino Caspar L 12 (Ti 6-Al 4-V)

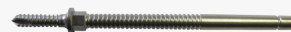

012314 Pino Caspar L 14 (Ti 6-Al 4-V)

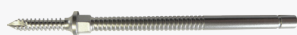

012316 Pino Caspar L 16 (Ti 6-Al 4-V)



018221 Prova S4/S5

PM CAGE® - INSTRUMENTAIS

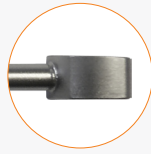

018222

Prova S6/S7



018223

Prova S8/S9



018224

Prova S10/S11



018231

Prova L4/L5



018232

Prova L6/L7



018233

Prova L8/L9



018234

Prova L10/L11

CONTAINER PARA TRANSPORTE

PM CAGE® CONTAINER PARA TRANSPORTE DE IMPLANTES E INSTRUMENTAIS



Item n° : 000040

↑
SUBSTITUÍDO POR :
↓



Item n° : 0B0808

ANOTAÇÕES

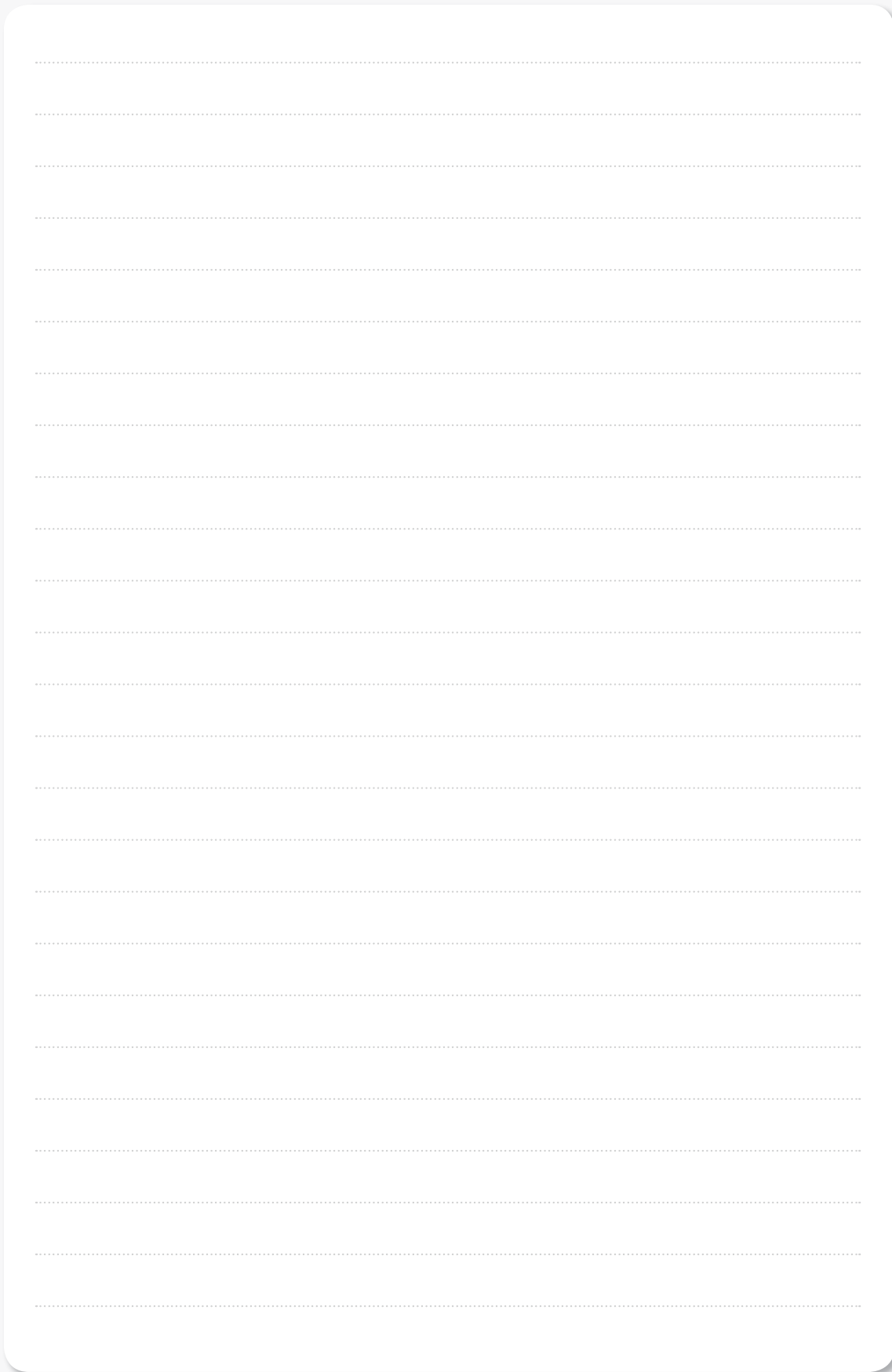

Your partner in spine surgery

NEURO FRANCE Implants



Spine

www.neuro-france.net

NEURO FRANCE Implants

ZA «le Bourg» - 25 rue des écoles 41160 La Ville aux Clercs - FRANCE

Phone : +33 2 54 80 90 90 - Fax : +33 2 54 80 83 33

Email : neurofrance@neuro-france.net



www.neuro-france.net

Distribuído por :



Avenida Luiz Eduardo Toledo Prado, 900 | sala: 619 - 620
Vila do Golf - Ribeirão Preto SP - Brasil CEP 14027-250